

Rosca métrica norma ISO 262

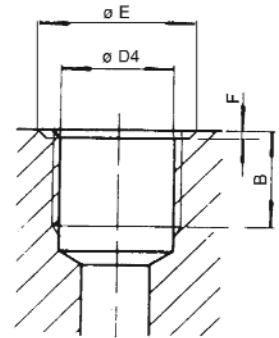

Métrica paralela	Métrica cônica	Métrica com O-Ring	A	B	D	D2	D3	D4	E	F
M 8x1	MK 8x1		8	11	8	12	-	7	18	
M 10x1	MK 10x1	M 10x1	8	11	10	14	18	9	20	
M 12x1,5	MK 12x1,5	M 12x1,5	12	15	12	17	20	10,5	23	
M 14x1,5	MK 14x1,5	M 14x1,5	12	15	14	19	22	12,5	25	
M 16x1,5	MK 16x1,5	M 16x1,5	12	15	16	21	24,2	14,5	28	
M 18x1,5	MK 18x1,5	M 18x1,5	12	16	18	23	26,5	16,5	30	
M 20x1,5			14	17	20	25	-	18,5		
M 22x1,5	MK 22x1,5	M 22x1,5	14	17	22	27	30	20,5	34	0,5 min
M 24x1,5			14	17	24	29	-	22,5		
M 26x1,5	MK 26x1,5		16	19	26	31	-	24,5		
M 27x2		M 27x2	16	19	27	32	40	25	40	
M 33x2		M 33x2	18	21	33	39	46	31	49	
M 42x2		M 42x2	20	23	42	49	54	40	60	
M 48x2		M 48x2	22	25	48	55	60	46		
M 60x2			24	26	60	68	-	58		
M 75x2			26	28	75	84	-	73		
M 88x2			28	30	88	98	-	86		

Flange SAE (3000 PSI)

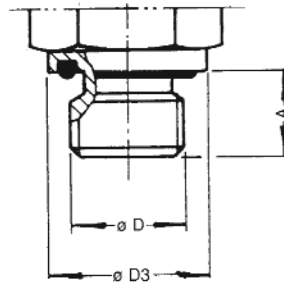
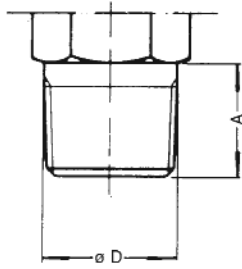
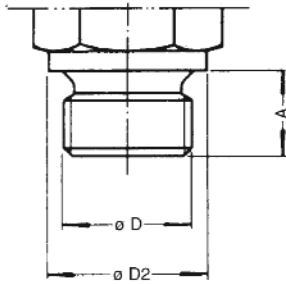
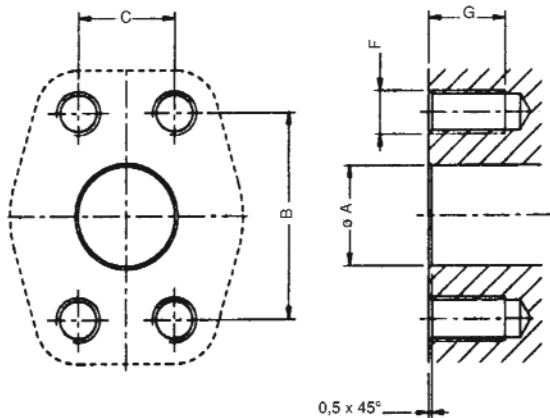

NPT	øA 0 -3	B	C	F		G
				métrica	UNC-28	
1/2"	13	38,1	17,5	M8	5/6-18	16
3/4"	19	47,6	22,2	M10	3/8-16	16
1"	25	52,4	26,2	M10	3/8-16	17
1.1/4"	32	58,7	30,2	M10	7/16-14	20
1.1/2"	38	69,9	35,7	M12	1/2-13	20

Flange SAE (6000 PSI)

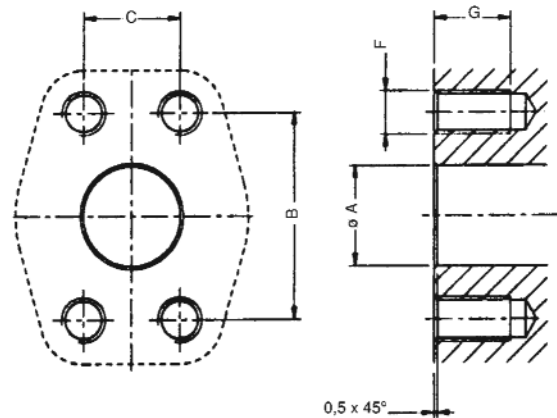

NPT	øA 0 -3	B	C	F		G
				métrica	UNC-28	
1/2"	13	40,5	18,2	M8	5/6-18	16
3/4"	19	50,8	23,8	M10	3/8-16	17
1"	25	57,2	27,8	M12	7/16-14	20
1.1/4"	32	66,7	31,8	M14	1/2-13	22
1.1/2"	38	79,4	26,6	M16	5/8-11	22

Vista Hydraulics

Av. Dr. Cassio Paschoal Padovani, 800 CEP13420-360 - Piracicaba - São Paulo

Tel: +55 19 2105-1700 / Fax: +55 19 2105-1718

vendas@vistahydraulics.com.br / www.vistahydraulics.com.br

Rosca NPT e UNF / SAE

Rosca NPT Cônica

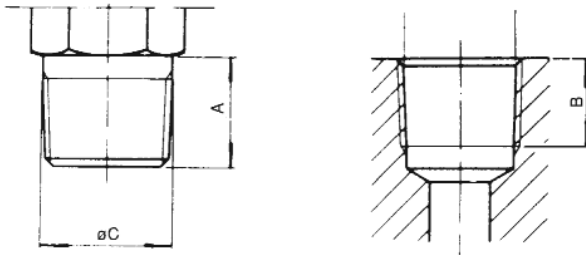

NPT	FIOS POR POLEGADA	A	B	C	D
1/8	27	10	9	10,4	9
1/4	18	14,2	12,5	13,9	11,7
3/8	18	14,2	13,5	17,3	15,2
1/2	14	19	16,5	21,6	18,8
3/4	14	19	17,5	27	24
1	11 1/2	24	20,5	33,7	30
1.1/4	11 1/2	25	21,0	42,5	38,8
1.1/2	11 1/2	25,5	21,0	48,7	45
2	11 1/2	26	22	60,7	57
2.1/2	8	38,5	30	73,5	68
3	8	40	32	89,4	84

Rosca UNF/SAE Paralela

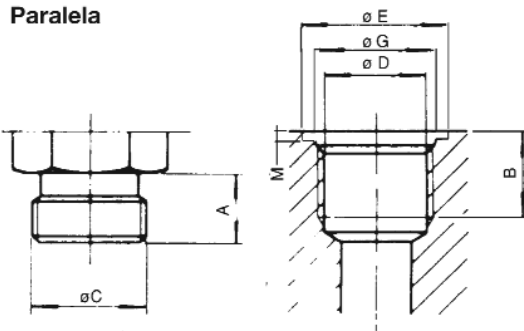

SAE	UNF paralela	FIOS POR POLEGADA	A	B	C	D	E	G	I	M	X
-	5/16	24	7,5	10	7,8	6,9					
-	3/8	24	7,5	10	9,4	8,5					
4	7/16	20	9,2	11,5	11	9,8	21,0	12,4	2,6	1,6	2,6
5	1/2	20	9,2	11,5	12,6	11,5	22,9	14,0	2,6	1,6	2,7
6	9/16	18	10	12,7	14,1	11,9	24,9	15,6	2,7	1,6	2,7
8	3/4	16	11,1	14,2	18,9	17,5	29,9	20,6	2,7	2,3	2,7
10	7/8	14	12,7	16,5	22,1	20,5	34,0	24,0	2,7	2,3	2,7
12	1 1/16	12	15	19	26,8	24,9	40,9	29,2	3,5	2,3	19
14	1 3/16	12	15	19	30	28	45,0	32,4	3,5	2,3	19
16	1 5/16	12	15	19	33,1	31,2	48,9	35,5	3,5	3,2	19
20	1 5/8	12	15	19	41,1	39,2	58,0	43,5	3,5	3,2	19
24	1 7/8	12	15	19	47,5	45,6	64,9	49,9	3,5	3,2	19

Rosca BSP norma ISO 228

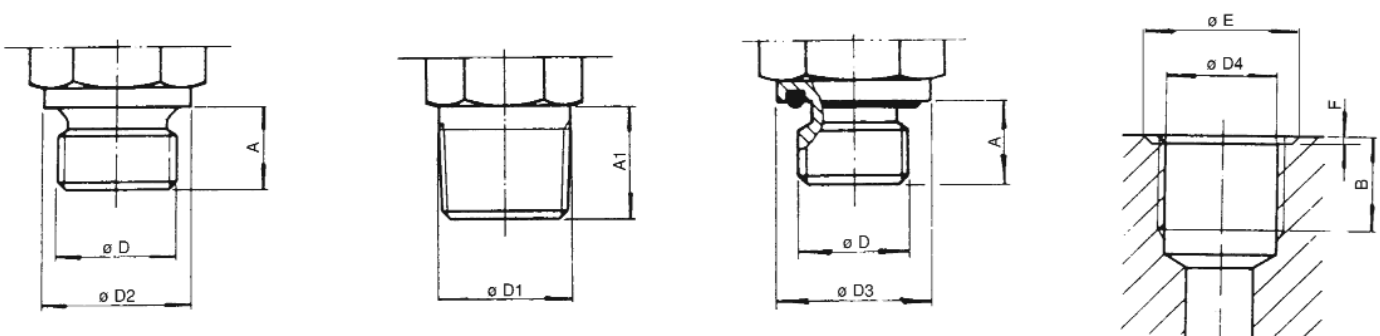

BSP paralela	BSPT cônica	BSP com O-Ring	FIOS p/ POL	A	A1	B	D	D1	D2	D3	D4	E	F
1/8 BSP	1/8 BSPT	1/8 BSP	28	8	10	10	9,6	10,1	14	18	8,8	17	0,5 min
1/4 BSP	1/4 BSPT	1/4 BSP	19	12	14,2	13	13	13,7	18	22	11,8	22	
3/8 BSP	3/8 BSPT	3/8 BSP	19	12	14,2	15	16,5	17,2	22	24,2	15,3	24	
1/2 BSP	1/2 BSPT	1/2 BSP	14	14	19	16	20,8	21,6	26	30	19	31	
3/4 BSP	3/4 BSPT	3/4 BSP	14	16	19	17	26,3	27	32	40	24,5	35	
1 BSP	1 BSPT	1 BSP	11	18	24	20	33	34,1	39	46	30,7	43	
1.1/4 BSP	1.1/4 BSPT	1.1/4 BSP	11	20	25	22	41,8	42,7	49	54	39,6	53	
1.1/2 BSP	1.1/2 BSPT	1.1/2 BSP	11	22	25,5	22	47,7	48,6	55	60	45,4	60	
2 BSP	2 BSPT	-	11	24	26	24	59,5	60,0	68	-	57,2	-	-
2.1/2 BSP	2.1/2 BSPT	-	11	26	38,5	26	75	75,5	87	-	72,7	-	-
3 BSP	3 BSPT	-	11	28	40	28	87,7	89	103	-	85,5	-	-

Voltar ao Índice